



# **ISOM 2017-2**

## International Specification for Orienteering Maps

Revision 6

January 2024

This International Specification for Orienteering Maps (ISOM 2017-2) has been compiled and edited by the IOF Map Commission (January 2019).

Changes of the ISOM were approved by the Council ESB in November 2018.  
Valid from 1st February 2024. Mandatory from 1st January 2025.



This work is licensed under a Creative Commons Attribution-NonCommercial 4.0 International Public License.  
For additional license information <https://creativecommons.org/licenses/by-nc/4.0/>  
For the full license text <https://creativecommons.org/licenses/by-nc/4.0/legalcode.txt>

ISBN: 978-91-639-3394-3

---

## **INTERNATIONAL ORIENTEERING FEDERATION**

Drottninggatan 47 3½ tr, SE-65225 KARLSTAD, SWEDEN

Website: [www.orienteering.sport](http://www.orienteering.sport)

E-mail: [iof@orienteering.sport](mailto:iof@orienteering.sport)

# IOF INTERNATIONAL SPECIFICATION FOR ORIENTEERING MAPS

## 1 INTRODUCTION

It is the aim of the International Specification for Orienteering Maps (ISOM) to provide a map specification which can accommodate the many different types of terrain around the world that are suitable for orienteering. These specifications should be read in conjunction with the rules for International Orienteering Federation (IOF) orienteering events. For IOF events, deviations from the map specifications are permissible only with the approval of the IOF. Other orienteering disciplines (mountain bike orienteering, trail orienteering and ski orienteering) and formats (sprint) may have separate map specifications, but the ISOM is the basis for the other specifications.

The development of orienteering maps reflects the needs of the sport and the technology available to produce them. In the very early days, at the end of the 19th century, state topographical maps at very small scales (e.g. 1:100 000) were often used. These were gradually produced at larger scales and additional detail was added. Aerial photographs and colour printing improved the accuracy and legibility of maps. This led to the production of special purpose orienteering maps in the 1950s. In the early days of international orienteering, the contents and symbols of orienteering maps varied from place to place. To ensure fair international competitions, standardisation was necessary, and this triggered the creation of the ISOM. The first official version was published in 1969. In ISOM 1972, green was introduced to show runnability, and orienteering maps started to look very much like they do today. Fortunately, the ISOM has been very well received, and most national federations have applied the ISOM also for maps used in local events. The ISOM now specifies about one hundred different symbols.

Digital cartography entered the stage in the 1990s. Up to that time, maps had been drawn with pen and ink or scribed onto film. These were then copied to printing plates, one for each colour, from which the maps were printed. Digital cartography has enabled greater precision in drawing, and easier modification of maps. Unfortunately, it has also helped mappers to overload maps with too much detail.

Other technological developments have also influenced orienteering mapping. Photogrammetry and, more recently, airborne laser scanning (or LiDAR - light detection and ranging) has provided better base maps. Global Navigation Satellite Systems (GNSS) can be used to provide precise locations during fieldwork. Printing technology is evolving and digital four-colour printing has provided new challenges for orienteering map printing. New types of paper (including waterproof paper) affect the printing process.

The previous ISOM version was published in 2000. Since then some technological developments have occurred as well as some changes in the event programme. These developments have been taken into consideration when revising the ISOM. However, the basic requirements have not changed. Map legibility is still the most important aspect of an orienteering map. In the process of producing a readable map, generalisation is the keyword. This means that the mapper must always deal with selection, simplification, displacement and exaggeration.

Skilful generalisation is necessary to ensure that maps are readable and suitable for orienteering competitions. The mapper must always consider that the orienteering map is read whilst running fast through the terrain, and that the perceptive capabilities of the human eye and brain have their limits.

## 1.1 Conventions

Several words are used to signify the requirements in this specification.

- *Must / Shall / Required* mean that the definition is an absolute requirement.
- *Must not / Shall not* mean that the definition is an absolute prohibition.
- *Should / Recommended* mean that there may exist valid reasons in particular circumstances to ignore a particular item, but the full implications must be understood and carefully weighed before choosing a different course.
- *Should not / Not recommended* mean that there may exist valid reasons in particular circumstances when the particular behaviour is acceptable or even useful, but the full implications should be understood and the case carefully weighed before implementing any behaviour/action described with this label.
- *May / Optional* mean that an item is truly optional.
- *Impassable / Uncrossable* features mean that a feature is too difficult or dangerous to go through or over by the average elite orienteer under normal conditions. It is not forbidden, but it may pose a risk to the competitor.

## 2 GENERAL REQUIREMENTS

### 2.1 Orienteering and the map

Orienteering is a sport in which the competitor (orienteer) completes a course of legs between control points in the shortest possible time, by navigating aided only by map and compass. As in all forms of sport, it is necessary to ensure that the conditions of competition are the same for all competitors.

From the competitors' point of view, a legible and accurate map is necessary for a qualified choice of route, and it enables them to navigate along the route chosen to suit their navigational skills and physical abilities. However, skill in route choice and map reading loses all meaning if the map is not a good representation of the ground - if it is of poor legibility, inaccurate or out-of-date. In the ideal case no competitor should gain an advantage or suffer a disadvantage because of faults on the map. For an international event the map must be up-to-date in all parts which could affect the result of the competition.

The steepness, elevation and shape of the landforms are essential information and are shown using contours. Identifying anything which impedes progress is crucial to the orienteer: e.g. cliffs, water, dense vegetation. The path and track network shows where the going and navigation is easiest. A detailed classification of the impediments to running and the ease of going helps the competitor to make the right decisions.

The aim of the course planner is a course where the deciding factor in the results will be navigational skill. This can be achieved only if the map is clear and legible under competition conditions and sufficiently accurate, complete and reliable. Controls are important building blocks of a course. Choice of sites, placing of the markers, checking their positions, and locating controls in competition, all put definite demands on the map. The better the map the course planners have, the greater chance they have of setting good, fair courses, whether for the elite orienteer or for the novice.

For the mapper, the task is knowing which features to map and how to represent them. A continuing involvement in the sport is important for a basic understanding of the requirements for the orienteering map: its content, the need for accuracy, the level of detail, and above all, the need for legibility.



## **2.2 Content**

An orienteering map is a topographical map. It shall serve navigation through the terrain by representing a selection of prominent features, and it shall serve route choice by showing variations in runnability (impact on speed) and visibility. The map shall contain sufficient information for the competing orienteer, while at the same time being legible at running speed and under varying weather and light conditions. This is accomplished by using a carefully designed set of symbols and colours and by emphasising generalisation.

Consistent use of colour is important to ease map reading: Blue is used for features that relate to water; Yellow is used for open areas; Green is used for vegetation features; Brown is used for landforms; Black and Grey are used for everything else, including rock and cliffs, paths and roads, and most man-made objects; Purple is used for course information.

The map shall only contain features which are obvious on the ground to a competitor at speed. It should show things which could influence map reading or route choice: landforms, rock features, ground surface, hindrance to progress through the vegetation (runnability), main land usage, hydrography, settlements and individual buildings, the path and track network, other lines of communication and features useful from the point of view of navigation. However, the most important thing is to maintain the clarity and legibility of the map through skilful generalisation.

The shape of the ground is the most important aspect of an orienteering map. The correct use of contours (including index contours) to show a three dimensional picture of the ground shape and height difference cannot be overemphasised.

An orienteer's speed and choice of route through the terrain is affected by many factors. Information on all of these factors must therefore be included on the map by classifying paths and tracks, by indicating whether marshes, water features, rock faces and vegetation are passable, by showing the characteristics of the ground surface and the presence of dense vegetation and open areas.

Clear boundaries between different types of ground surface and different types of vegetation provide valuable reference points for the map reader. It is important that the map shows these.

The map must contain magnetic north lines that shall be parallel to the sides of the map. It may additionally contain some place names and peripheral text to help the competitor orientate the map to north. Such text shall be orientated to north. Text within the map shall be placed to avoid obscuring important features and the style of lettering should be simple. Arrowheads may be used to show magnetic north.

## **2.3 Runnability**

The runnability depends on the nature of the terrain (density of trees/scrub and undergrowth, i.e. bracken, brambles, nettles, as well as marshes, stony ground, etc.). Runnability is divided into five categories of speed. If speed through flat and open runnable forest is 4 min/km, the following applies:

A combination of a green screen and stony ground means that the runnability will be worse than for each of them in isolation. The steepness of the terrain may also influence runnability (the steeper the terrain, the less runnable).

No	Percentage	Description	Examples	Approx speed (min/km)
1	> 100%	Easy running	Lawns, paved areas, paths	< 4
2	80 - 100%	Normal running speed	Rough open land, forest	< 5
3	60 - 80%	Slow running	Stony ground, undergrowth, dense vegetation	5-6:40
4	20 - 60%	Walk / Difficult to run	Very stony ground, undergrowth, dense vegetation	6:40-20
5	< 20%	Fight	Extremely stony ground, very dense vegetation	> 20

## 2.4 Barriers

In orienteering terrain, there may be features that are effectively impassable or uncrossable. Examples are buildings, fences, walls, high cliffs, water bodies, uncrossable marshes and very dense vegetation. There may also be features that are out-of-bounds to the competitor, that is, they shall not be crossed or entered. Examples are environmentally sensitive areas and private land.

Such features are very important for route choice and may also present a danger to the competitor. They must be clearly identifiable on the map by using very visible symbols as indicated in this specification.

In an ideal world, all features mapped using barrier symbols would be impossible to pass / cross. But nature is complex, conditions vary over time, maps have to be generalised, and the competitors do not have equal physical abilities. This means that a feature that is mapped using a barrier symbol could turn out to be passable / crossable, but to what extent it is possible to pass / cross cannot be determined by inspecting the map.

That a feature is not mapped as impassable does not mean that it will be passable by all orienteers. It should, however, be passable by the average elite orienteer under normal conditions.

## 2.5 Map reading

The mapper must always take into consideration the special conditions for orienteering map reading. Firstly, running makes reading a map more difficult. Secondly, orienteering often takes place in forests, and in all kinds of weather. The light in forests with dense canopies is dimmed even in the middle of the day, and there are numerous other factors that impact map reading, such as rain, dirt and damages to the map or plastic bag caused by rough handling. Therefore, it is obvious that legibility is of utmost importance for orienteering maps. Minimum graphical dimensions must be respected and unnecessary detail must be avoided.

## 2.6 Generalisation and legibility

Good orienteering terrain contains a large number and a great variety of features. Those which are most essential for the competitor must be selected and presented on the orienteering map. To achieve this, in such a way that the map is legible and easy to interpret, generalisation must be employed. There are two phases of generalisation: selective generalisation and graphical generalisation.

Selective generalisation is the decision as to which detail and features should be presented on the map. Two important considerations contribute to this decision: the importance of the feature from the competitor's point of view, and its influence on the legibility of the map. These two considerations will sometimes be incompatible, but the demand for legibility must never be relaxed in order to present an excess of details and features on the map. Therefore, it will be necessary at the survey stage to adopt minimum sizes for many types of detail. These minimum sizes may vary somewhat from one map to another according to the amount of detail in question. However, consistency is one of the most important qualities of the orienteering map.

Graphical generalisation can greatly affect the clarity of the map. Simplification, displacement and exaggeration are used to this end.

Legibility requires that the size of symbols, line thicknesses and spacing between lines be based on the perception of normal sight in daylight. In devising symbols, all factors except the distance between neighbouring symbols have been considered.

The size of the smallest feature which will appear on the map depends partly on the graphical qualities of the symbol (shape, format and colour) and partly on the position of neighbouring symbols. With immediately neighbouring features which take up more space on the map than on the ground, it is essential that the correct relationships between these and other nearby features are also maintained.

For orienteering maps, the shape of the terrain is the most important thing to communicate. Dangerous features, such as high cliffs, must be easy to see on the map. Anything that is out-of-bounds or may bar or impede progress is essential information: long cliffs, water, dense thickets, private property. The road, path and track network is important, since it shows where the going and navigation is easiest. Most point features are of less importance than line and area features.

## **2.7 Accuracy**

The general rule should be that competitors shall not perceive any inaccuracy in the map. The accuracy of the map as a whole depends upon the accuracy of measurement (position, height and shape) and the accuracy of drawing. A feature must be positioned with sufficient accuracy to ensure that a competitor using compass and pacing will perceive no discrepancy between map and ground.

Absolute height accuracy is of little significance on an orienteering map. On the other hand, it is important that the map shows as correctly as possible the relative height difference between neighbouring features.

Accurate representation of shape is of great importance for the orienteer, because a correct, detailed and sometimes exaggerated picture of the landform is an essential precondition for map reading. However, the inclusion of a lot of detail must not disguise the overall shape. This means that form line usage must be limited to an absolute minimum (e.g. form lines with a shape that can be deduced from the neighbouring contours shall not appear on the map) and insignificant contour detail must be removed.

Drawing accuracy is of primary importance to any map user because it is closely connected with the reliability of the final map.

Absolute accuracy is important if an orienteering map is to be used with positioning systems or together with geographical datasets from other sources. In such cases it must also be possible to transform the map to a wellknown geographical reference system. Readability is always more important than absolute accuracy. Displacement of map features is encouraged if it makes the map more readable.

## **2.8 Georeferencing**

To georeference a map means to locate it using a geographical reference system. Georeferencing is useful when geographical data from different sources (e.g. orienteering map, digital elevation model, aerial photos, GNSS positions) need to be combined, and it is useful when tracking competitors during a race. It is therefore strongly recommended to produce georeferenced orienteering maps. However, before printing the map, it shall first be rotated to make the magnetic north lines parallel to the edges of the map page.

## **2.9 Map scale**

The base scale for an orienteering map is 1:15 000.

Generalisation shall follow the requirements for the scale 1:15 000.

### **2.9.1 Map enlargement**

The IOF competition rules regulate the use of map enlargements for IOF events. When a map is enlarged, all lines, symbols and screens shall be enlarged proportionally (for the map scale 1:10 000 this means to 150%). This also applies to the course planning symbols.

For older age groups where reading fine lines and small symbols may cause problems due to deteriorating vision, enlarged maps are recommended for all formats. Enlargement to the scale 1:10 000 is always recommended for the youngest age groups where the capacity of reading complex maps is not fully developed.

Large maps are difficult to handle. Maps larger than A3 should be avoided. A map should not be larger than is necessary for the orienteering competition. Large maps should be cut to fit the course (however, they should not be smaller than A5). Information about scale, contour interval and north direction shall be available also on cut maps.

## **2.10 Contour interval**

The ability to easily assess the steepness of the terrain is vital in orienteering. It is therefore very important that the contour interval for orienteering maps is standardised.

The contour interval for orienteering maps is 5 m. In flat terrain where the slope is less than 5% (or the contours would be more than 7 mm apart) all over the area, 2.5 m contours may be used. Different contour intervals shall not be used on the same map.

The presence of a form line between contours makes the terrain appear nearly twice as steep. It is therefore very important that form lines are used sparingly. Form lines shall only be used to represent important landforms that cannot be shown using contours. Instead of using form lines, contours should be shifted slightly up or down to better represent the important landforms.

## 2.11 Minimum dimensions

For line and area symbols certain minimum dimensions must be observed. These are based on both printing technology and the need for legibility. Dimensions in this specification are given at the printed scale of 1:15 000.

### 2.11.1 On the ground (real world) minimum dimensions

Features that are represented on an orienteering map shall be prominent and easily identifiable by the orienteer whilst running. Minimum on the ground dimensions are provided for many of the symbols in this specification and these must be respected. Minimum dimensions do not mean that all features larger than that need to be represented on the map. For complex terrain, it will often be necessary to operate with larger minimum dimensions to achieve a legible map.

Prominent features with small terrain footprints are exaggerated on the map (for instance by using a point symbol) to make them identifiable. When a feature is exaggerated on the map, neighbouring features may need to be displaced to ensure readability and correct relative positions.

### 2.11.2 Footprint of symbols

There has to be minimum dimensions for line and area symbols on a map. These are termed graphical minimum dimensions. The footprint of a symbol is the area the symbol would cover if it was projected onto the terrain.

For a line symbol, the graphical minimum dimension concerns its length on the map. If a line is too short on the map, it ceases to look like a line, and can be mistaken for a point symbol. Also, styled line symbols must not be made so short that the symbol becomes unrecognisable. If there is room on the map and the line feature is prominent and significant, it could be mapped even if it is shorter than the footprint of the minimum size line. However, it must always be exaggerated in size on the map to meet the graphical minimum length. A bent line may have to be drawn longer than the minimum length in order to make it recognisable.



For an area symbol, the graphical minimum dimension concerns the area covered by the symbol on the map. If the area is too small, it will be difficult to differentiate it from point symbols, it becomes 'noise' to the map user or the structure of the symbol will become unrecognisable. If the area is too narrow, it will be difficult to differentiate it from line symbols, and a structured area symbol will become unrecognisable. If there is room on the map and the area feature is prominent and significant it can be mapped even if it is smaller than the footprint of the minimum size area or narrower than the footprint of the minimum width. However, it must always be exaggerated to meet the minimum graphical dimensions.

### 2.11.3 Graphical minimum dimensions

The graphical minimum dimensions apply to the base scale of 1:15 000. This means that for enlarged maps, the graphical minimum dimensions will be proportionally larger (1.5 times larger for the 1:10 000 map scale). For instance for a *Cliff* (202), the minimum length on the map is 0.6 mm. This means that for the map scale 1:10 000, the minimum length on the map for a cliff is 0.9 mm.

Where graphical minimum dimensions are given for individual symbols, these take precedence. For other symbols the following graphical minimum dimensions apply.

## Minimum gaps

To be able to identify the individual symbols, minimum gaps are important. In general, the minimum gap of 0.15 mm applies. The minimum gap between two symbols is the minimum distance between the outlines of the symbols. Listing all symbol combinations is not practical, but the following strong recommendations should be combined with common sense.

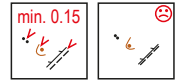
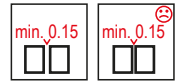

For point symbols, the general gap of 0.15 mm applies.



The minimum gap between point symbols and line symbols including outlines of area symbols should be 0.15 mm, with exceptions for gaps between contours and point symbols of other colours. Cliffs may overlap knolls.



The minimum gap between line symbols including outlines of area symbols of the same colour is 0.15 mm, with some exceptions:

- Joins and crossings of network symbols (earth walls, watercourses, roads, tracks and paths, power lines, walls and fences).
- Crossings, such as *Contours* (101) and *Earth walls* (105, 106) and *Erosion gully* (107); *Wall* (513) and *Footpath* (505); *Major power line* (511) and *Fence* (516).
- *Contours* (101) and *Earth bank* (104).

For legibility reasons, overlapping between line symbols (including outlines of area symbols) of different colours should be avoided, and the minimum gap of 0.15 mm should be applied. There are however exceptions:

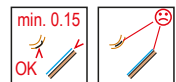

- Contours and cliffs should at least partly overlap
- Crossings, such as water courses and contours; fences and water courses.

The minimum gap of 0.15 mm only applies to the following types of area symbols:

- Area symbols with outlines, such as *Uncrossable body of water* (301), *Shallow body of water* (302), *Uncrossable marsh* (307), *Paved area* (501), *Out-of-bounds area* (520), *Canopy* (522) and *Ruin* (523).
- Symbols consisting exclusively of an area (not surrounded by an outline), such as *Gigantic boulder or rock pillar* (206) and *Building* (521, 0.4 mm).

For area symbols in brown, black and blue with structure, such as broken ground, boulder field, stony ground and marsh symbols, it is important that the elements of the symbols do not interfere significantly with point and line symbols.



Passages between symbols representing impassable / uncrossable features, except *Impassable cliff* (201) and *Gigantic boulder or rock pillar* (206), must be clearly recognizable, so the minimum gap should be 0.4 mm. Examples are symbols *Building* (521)

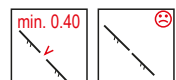

and *Out-of-bounds area* (520); *Building* (521) and *Impassable wall* (515); *Building* (521) and *Building* (521).

Openings in line symbols that represent impassable features (fence, wall) must be clearly recognizable and need to be at least 0.4 mm wide. For other line features, a minimum opening of 0.25 mm applies.

## Minimum line length

Line symbols need to be long enough to differentiate them from other symbols. Closed lines must have sufficient white space within to allow the line symbol to be recognized. For closed styled lines such as fences, walls and cliffs, there must be enough room for the styling (e.g. tags), so that the type of symbol can be recognized.

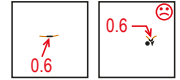

## Rendering of dashed lines, dotted lines and styled lines

### Dashed lines:

The dash length at the start and end of a dashed line should be the same. The gaps shall always be as given in the symbol specification. The dashes shall always be as close to the dash length given in the symbol specification as possible, and never shorter than 0.8 times the given length.

### Dotted lines:

The gap between the dots at the start and end of a dotted line should be the same. The gaps shall always be as close to the gap given in the symbol specification as possible, and never shorter than 0.8 times the given length.

### Styled lines:

The end length at the start and end of the line should be the same. The distance between style symbols on a styled line shall always be as close to the distance given in the symbol specification as possible, and never shorter than 0.8 times the given length. The end length shall be half the distance between the symbols.

### Styled dashed lines:

Dash length shall follow the rules for dashed lines, and the style symbol shall always be centered on the dash.

## Minimum dimensions for areas

Providing minimum dimensions for areas is difficult as the shape varies. The minimum width is as important as the minimum area. Very thin parts of areas must be exaggerated. Minimum widths for area symbols (if not specified for the symbol):

100% green: 0.25 mm (footprint 3.75 m).

100% yellow: 0.3 mm (footprint 4.5 m).

Colour screens: 0.4 mm (footprint 6 m).



## 2.11.4 Screens

Vegetation, open areas, marshes, etc. are shown with dot or line screens. The table below lists the permissible combinations of screens.

		113-114 Broken ground	208 Boulder field	209 Dense boulder field	210-212 Stony ground	307 Uncrossable marsh	308 Marsh	310 Indistinct marsh	407 Vegetation slow, good visibility	409 Vegetation walk, good visibility
302 Shallow body of water		✗				✗	✗	✗	✗	✗
308 Marsh						✗	✗	✗		
310 Indistinct marsh						✗	✗	✗		
401 Open land				✗		✗		✗	✗	✗
402 Open land with scattered trees				✗		✗		✗	✗	✗
402 ...with green dots				✗		✗		✗	✗	✗
403 Rough open land										
404 Rough open land with scattered trees										
404 ...with green dots								✗	✗	✗
405 Forest										
406 Vegetation, slow						✗			✗	✗
408 Vegetation, walk						✗			✗	✗
410 Vegetation, fight						✗			✗	✗



## **2.12 Printing and colour**

The document *IOF Map Specifications - Printing and Colour Definitions* applies.

## **2.13 Peripheral information**

The following information shall be provided on the front of the map:

- Map scale
- Contour interval.

Other information that is often included:

- Name of the map
- Map issuer
- Date of the map (year of surveying)
- Map specification
- Name of mappers
- Name of print shop
- Copyright.

### 3. SYMBOLS

Definitions of features to be mapped and specifications of map symbols are given in the following sections. Symbols are classified into seven categories:

Landforms	(brown)
Rock and boulders	(black+grey)
Water and marsh	(blue)
Vegetation	(green+yellow)
Man-made features	(black)
Technical symbols	(black+blue)
Course planning symbols	(purple)

**Note: dimensions are specified in mm at the scale of 1:15 000.**

All drawings are at 1:7 500 for clarity only.

**Type of symbols:**

P .....	Point
L .....	Line
A .....	Area
T .....	Text

- < gap or infill between two lines
- line thickness
- distance
- ∅ diameter

symbol orientated to north

(OM) = Outside measure

(IM) = Inside measure

(CC) = Centre to centre

Most of the symbols in this specification shall be orientated to north. That a symbol is to be orientated to north is indicated with an arrow pointing upward beside the symbol. When a symbol shall be orientated to north, it means that it shall be orientated to magnetic north and hence relative to the edges of the paper and the magnetic north lines.

For area symbols, colour percentages are given in the text (“green 50%”) and the illustrations (“50%”). Detailed graphical definitions for some of the symbols are provided in section 3.8 *Precise definitions of symbols*.

#### 3.1 Landforms

The shape of the terrain is shown by means of contours, aided by special symbols for small knolls, depressions, etc. This is complemented in black by symbols for rock and cliffs.

While it is important to show the smaller features of the terrain, such as re-entrants, spurs, knolls and depressions, it is essential that an abundance of small features do not hide the main features of the terrain, such as hills, valleys and major fault lines.

Excessive use of form lines must be avoided as this complicates the map and gives a wrong impression of height differences.

##### 101 Contour (L)

A line joining points of equal height. The standard vertical interval between contours is 5 m. A contour interval of 2.5 m may be used for flat terrains.

Slope lines may be drawn on the lower side of a contour line to clarify the direction of slope. When used, they should be placed in re-entrants.

A closed contour represents a knoll or a depression. A depression has to have at least one slope line. Minimum height/depth should be 1 m.

Relationships between adjacent contour lines are important. Adjacent contour lines show form and structure. Small details on contours should be avoided because they tend to hide the main features of the terrain.

Prominent features such as depressions, re-entrants, spurs, earth banks and terraces may have to be exaggerated.

Absolute height accuracy is of little importance, but the relative height difference between neighbouring features should be represented on the map as accurately as possible. It is permissible to alter the height of a contour slightly if this improves the representation of a feature. This deviation should not ex-

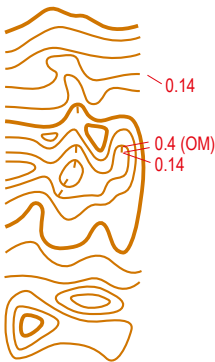

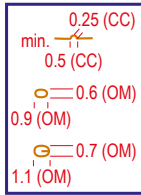

ceed 25% of the contour interval, and attention must be paid to neighbouring features.

The smallest bend in a contour line is 0.25 mm from centre to centre of the line (footprint 4 m). The mouth of a re-entrant or a spur must be wider than 0.5 mm from centre to centre of the line (footprint 8 m).

The minimum length of a contour knoll is 0.9 mm (footprint 13.5 m) and the minimum width is 0.6 mm (footprint 9 m) outside measure. Smaller prominent knolls can be represented using symbol *Small knoll* (109) or *Small elongated knoll* (110) or they can be exaggerated on the map to satisfy the minimum dimension.

A depression must accommodate a slope line, so the minimum length is 1.1 mm (footprint 16.5 m) and the minimum width is 0.7 mm (footprint 10.5 m) outside measure. Smaller prominent depressions can be represented using symbol *Small depression* (111) or they can be exaggerated to satisfy the minimum dimension.

Contours shall be adapted or broken in order not to touch symbol *Small knoll* (109) or *Small elongated knoll* (110).

Colour: brown.

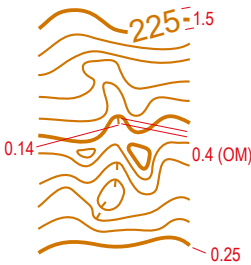

### 102 Index contour (L, T)

Every fifth contour shall be drawn with a thicker line. This is an aid to the quick assessment of height difference and the overall shape of the terrain surface.

An index contour may be represented as an ordinary contour line in an area with much detail. Small contour knolls and depressions are normally not represented using index contours.

The index contour level must be carefully selected in flat terrain. The ideal level for the index contour is the central contour in the most prominent slopes. An index contour may have a height value assigned. A height value should only be inserted in an index contour in places where other detail is not obscured. It shall be orientated so that the top of the label is on the higher side of the contour. The index value (label) shall be 1.5 mm high and represented in a sans-serif font.

Colour: brown.

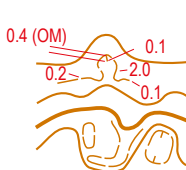

### 103 Form line (L)

Form lines are used where more information must be given about the shape of the ground. Form lines are added only where representation would be incomplete with ordinary contours. They shall not be used as intermediate contours. Only one form line should be used between neighbouring contours. It is very important that a form line fits logically into the contour system, so the start and end of a form line should be parallel to the neighbouring contours. The gaps between the form line dashes must be placed on reasonably straight sections of the form line. Form lines can be used to differentiate flat knolls and depressions from more distinct ones (minimum height / depth should be 1 m). Excessive use of form lines must be avoided as this disturbs the three-dimensional picture of the ground shape and will complicate map reading.

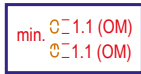

Minimum length (non-closed): two dashes.

Minimum length of a form line, knoll or depression: 1.1 mm (footprint 16.5 m) outside measure.

Colour: brown.

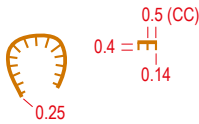

### 104 Earth bank (L)

An earth bank is an abrupt change in ground level which can be clearly distinguished from its surroundings, e.g. gravel or sand pits, road and railway cuttings or embankments.

Minimum height: 1 m. An earth bank may impact runnability. The tags represent the full extent of the earth bank.

For long earth banks it is allowed to use tags shorter than the minimum length at the ends. If two earth banks are close together, tags may be omitted. Impassable earth banks shall be represented using symbol *Impassable cliff* (201).

Minimum length: 0.6 mm (footprint 9 m).

Colour: brown.

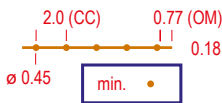

### 105.1 Earth wall (L)

Distinct earth wall. Minimum height: 1 m.

Minimum length: 1.4 mm (footprint 21 m).

Colour: brown.

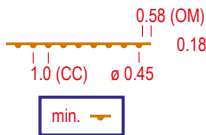

### 105.2 Retaining earth wall (L)

A retaining earth wall is an abrupt change in ground level which can be clearly distinguished from its surroundings used for minor peat edges and cultivation terraces. If such a feature is higher than 1 m, it should be drawn with the symbol *Earth bank* (104).

Minimum height: 0.5 m, minimum length (isolated): 1.4 mm.

Colour: brown.

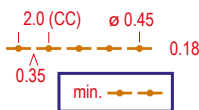

### 106 Ruined earth wall (L)

A ruined or less distinct earth wall. Minimum height: 0.5 m.

Minimum length: two dashes (3.65 mm - footprint 55 m). If shorter, the symbol must be exaggerated to the minimum length or changed to symbol *Earth wall* (105).

Colour: brown.



### 107 Erosion gully (L)

An erosion gully which is too small to be shown using symbol *Earth bank* (104) is shown by a single line. Contour lines may be broken around this symbol for better readability.

Minimum depth: 1 m.

Minimum length: 1.15 mm (footprint 17.25 m).

Colour: brown.



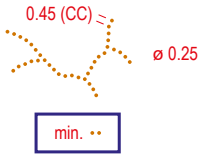

### 108 Small erosion gully (L)

A small erosion gully or dry ditch. Minimum depth: 0.5 m.  
 Minimum length (isolated): two dots (0.7 mm - footprint 10.5 m).  
 Contour lines shall be broken around this symbol.  
 Colour: brown.



### 109 Small knoll (P)

An obvious mound or knoll which cannot be drawn to scale with a contour.  
 Minimum height: 1 m.  
 The symbol shall not touch or overlap contours.  
 Footprint: 7.5 m x 7.5 m.  
 Colour: brown.



### 110 Small elongated knoll (P)

An obvious elongated knoll which cannot be drawn to scale with a contour.  
 Minimum height: 1 m.  
 The symbol shall not touch or overlap contours.  
 Footprint: 12 m x 6 m.  
 Colour: brown.

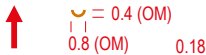

### 111 Small depression (P)

A small depression or hollow without steep sides that is too small to be shown by contours. Minimum depth: 1 m, minimum width: 2 m.  
 Small depressions with steep sides are represented with symbol *Pit* (112).  
 The symbol shall not touch or overlap other brown symbols. Location is the centre of gravity of the symbol, and the symbol is orientated to north.  
 Footprint: 12 m x 6 m.  
 Colour: brown.

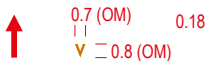

### 112 Pit (P)

A Pit or hole with distinct steep sides which cannot be shown to scale using symbol *Earth bank* (104). Minimum depth: 1 m, minimum width: 1 m.  
 A pit larger than 5 m x 5 m should normally be exaggerated and drawn using *Earth bank* (104). Pits without steep sides are represented with symbol *Small depression* (111).  
 The symbol shall not touch or overlap other brown symbols. Location is the centre of gravity of the symbol, and the symbol is orientated to north.  
 Footprint: 10.5 m x 12 m.  
 Colour: brown.

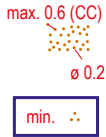

### 113 Broken ground (A)

An area of pits and / or knolls which is too intricate to be shown in detail, or other types of rough and uneven ground that is clearly distinguishable but has little impact on runnability.

The dots should be randomly distributed but not interfere with the representation of important terrain features, objects and contours.

The minimum number of dots is three (footprint 10 m x 10 m).

The maximum centre to centre distance between neighbouring dots is 0.6 mm.

The minimum centre to centre distance between neighbouring dots is 0.5 mm.

The dots shall not be arranged to form a single point wide line.

Density: 3-4 dots / mm<sup>2</sup>.

Colour: brown.

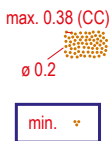

### 114 Very broken ground (A)

An area of pits and/or knolls, which is too intricate to be shown in detail, or other types of rough and uneven ground that is clearly distinguishable and affects runnability.

The dots should be randomly distributed but not interfere with the representation of important terrain features and objects.

The minimum number of dots is three (footprint 7 m x 7 m).

The maximum centre to centre distance between neighbouring dots is 0.38 mm.

The minimum centre to centre distance between neighbouring dots is 0.25 mm.

Contours should not be cut in broken ground areas.

The dots shall not be arranged to form a single point wide line.

Density: 7-9 dots / mm<sup>2</sup>.

Colour: brown.



### 115 Prominent landform feature (P)

The feature must be very clearly distinguishable from its surroundings.

Location is the centre of gravity of the symbol, which is orientated to north.

The symbol shall not touch or overlap other brown symbols.

The definition of the symbol must be given on the map.

Footprint: 13.5 m x 11.5 m.

Colour: brown.

### 3.2 Rock and boulders

Rock is a special category of landform. The inclusion of rock gives useful information about danger and runnability as well as providing features for map reading and control points. Rock is shown in black to distinguish it from other landform features. Care must be taken to make sure that rock features such as cliffs fit with the shape and fall of the ground as shown by contours.

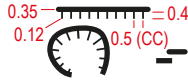

#### 201 Impassable cliff (L)

A cliff, quarry or earth bank that is so high and steep that it is impossible to pass/climb or is dangerous.

For vertical rock faces the tags may be omitted if space is short. Ends of the top line may be rounded or square. Shorter tags may be used at the ends.

The gap between two impassable cliffs or between impassable cliffs and other impassable feature symbols must exceed 0.25 mm on the map.

When an impassable cliff drops straight into water, making it impossible to pass under the cliff along the water's edge, the bank line is omitted or the tags shall clearly extend over the bank line. An impassable cliff should interplay with the contour lines.

Minimum length: 0.6 mm (footprint 9 m).

Colour: black.

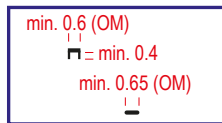

#### 202 Cliff (L)

A passable cliff or quarry. If the direction of fall of the cliff is not apparent from the contours, or to improve legibility, short tags may be drawn in the direction of the downslope.

For non-vertical cliffs, the tags should be drawn to show the full horizontal extent. Ends of the base line must be rounded if no tags appear. A passage between two cliffs must be at least 0.15 mm. A cliff should interplay with the contour lines.

Crossing a cliff will normally slow progress.

Minimum height: 1 m.

Minimum length: 0.6 mm (footprint 9 m).

Colour: black.

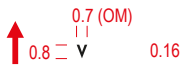

#### 203.1 Rocky pit or cave (P)

Rocky pits, holes, caves or mineshafts which may constitute a danger to the competitor.

Location is the centre of gravity of the symbol, and the symbol shall be orientated to north, except for caves with a distinct entrance, where the symbol should point into the cave.

Rocky pits larger than 5 m in diameter should be exaggerated and represented using cliff symbols (201, 202).

Minimum depth: 1 m.

Footprint: 10.5 m x 12 m.

Colour: black.

0.9 (OM)  
 | |  
 ● 0.35

### 203.2 Dangerous pit (P)

A highly dangerous pit, vertical shaft or abyss where a fall into the pit could cause severe injury or death. It is strongly recommended not to use such a feature as a control point. If this object is part of a possible route choice, it should be marked in the terrain with tape.

Footprint: 13.5 m diameter.

Colour: black, white.

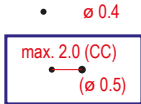

### 204 Boulder (P)

A distinct boulder (should be higher than 1 m), which is immediately identifiable on the ground. Groups of boulders are represented using symbol *Boulder cluster* (207) or a boulder field symbol (208, 209).

To be able to show the distinction between neighbouring (closer than 30 m apart) boulders with significant difference in size, it is permitted to enlarge the symbol to 0.5 mm for some of the boulders.

Footprint: 6 m diameter (7.5 m diameter).

Colour: black.

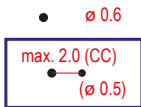

### 205 Large boulder (P)

A particularly large and distinct boulder. A large boulder should be more than 2 m high. To be able to show the distinction between neighbouring (closer than 30 m apart) large boulders with significant difference in size, it is permitted to reduce the size of the symbol to 0.5 mm for some of the boulders.

Footprint: 9 m diameter (7.5 m diameter).

Colour: black.



### 206 Gigantic boulder or rock pillar (A)

A gigantic boulder, rock pillar or massive cliff shall be represented in plan shape. The objects can vary in shape and width.

The gap between gigantic boulders or between gigantic boulders and other impassable feature symbols must exceed 0.15 mm on the map.

Minimum width: 0.25 mm (footprint 3.75 m).

Minimum area: 0.3 mm<sup>2</sup> (footprint 67 m<sup>2</sup>).

Colour: black.

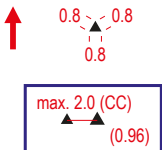

### 207 Boulder cluster (P)

A distinct group of boulders so closely clustered together that they cannot be marked individually. The boulders in the cluster should be higher than 1 m.

A boulder cluster must be easily identifiable as a group of boulders.

To be able to show the distinction between neighbouring (maximum 30 m apart) boulder clusters with significant difference in boulder size, it is permitted to enlarge this symbol to 120% (edge length 0.96 mm) for some of the boulder clusters.

The symbol is orientated to north.

Footprint: 12 m x 10 m.

Colour: black.



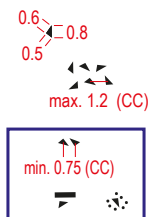

### 208 Boulder field (A)

An area which is covered with so many scattered blocks of stone that they cannot be marked individually, is shown with randomly placed and orientated solid triangles with sides of ratio 8:6:5 (inner angles: 92.9, 48.5, 38.6). A boulder field will generally not impact runnability. If the runnability of the boulder field is reduced, symbol 209 (dense boulder field) should be used or the symbol should be combined with a stony ground symbol.

A minimum of two triangles should be used. One triangle may be used if it is combined with other rock symbols (for instance directly below cliff symbols (201, 202), adjacent to boulder symbols (204-206) or combined with stony ground symbols (210-212)).

The maximum centre to centre distance between neighbouring triangles is 1.2 mm. The minimum centre to centre distance between neighbouring triangles is 0.75 mm.

Density: 0.8-1 symbol / mm<sup>2</sup>. To be able to show obvious height differences within a boulder field, it is permitted to enlarge some of the triangles to 120%. Footprint of individual triangle: 12 m x 6 m.

Colour: black.

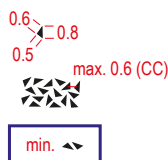

### 209 Dense boulder field (A)

An area which is covered with so many blocks of stone that they cannot be marked individually and the runnability is affected, is shown with randomly placed and orientated solid triangles with sides of ratio 8:6:5 (inner angles: 92.9, 48.5, 38.6). A minimum of two triangles must be used.

The maximum centre to centre distance between neighbouring triangles is 0.6 mm.

Density: 2-3 symbols / mm<sup>2</sup>. To be able to show obvious height differences within a boulder field, it is permitted to enlarge some of the triangles to 120%. Footprint of individual triangle: 12 m x 6 m.

Colour: black.

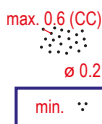

### 210 Stony ground, slow running (A)

Stony or rocky ground which reduces runnability to about 60-80% of normal speed.

The dots should be randomly distributed but not interfere with the representation of important terrain features and objects. Illustration serves as an example of density and also point symbol (single dots) can be used to draw stony ground.

The minimum number of dots is three (footprint 10 m x 10 m).

The maximum centre to centre distance between neighbouring dots is 0.6 mm. The minimum centre to centre distance between neighbouring dots is 0.45 mm. Density: 3-4 dots / mm<sup>2</sup>.

To avoid confusion with symbol *Distinct vegetation boundary* (416), the dots should not be arranged to form a line.

Colour: black.

∅ 0.2



min. ▾

### 211 Stony ground, walk (A)

Stony or rocky ground which reduces the runnability significantly (to about 20-60% of normal speed).

The dots should be randomly distributed but not interfere with the representation of important terrain features and objects. Illustration serves as an example of density and also point symbol (single dots) can be used to draw stony ground.

The minimum number of dots is three (footprint 8 m x 8 m).

The maximum centre to centre distance between neighbouring dots is 0.4 mm.

The minimum centre to centre distance between neighbouring dots is 0.32 mm.

Density: 6-8 dots / mm<sup>2</sup>.

To avoid confusion with symbol *Distinct vegetation boundary* (416), the dots should not be arranged to form a line.

Colour: black.

∅ 0.2



min. ▾

### 212 Stony ground, fight (A)

Stony or rocky ground which is hardly passable (less than 20% of normal speed).

The dots should be randomly distributed but not interfere with the representation of important terrain features and objects. Illustration serves as an example of density and also point symbol (single dots) can be used to draw stony ground.

The minimum number of dots is three (footprint 7 m x 7 m).

The maximum centre to centre distance between neighbouring dots is 0.32 mm.

The minimum centre to centre distance between neighbouring dots is 0.25 mm.

Density: 10-12 dots / mm<sup>2</sup>.

To avoid confusion with symbol *Distinct vegetation boundary* (416), the dots should not be arranged to form a line.

Colour: black.

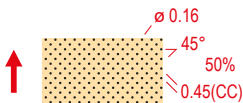

min. ☐

### 213 Sandy ground (A)

An area of soft sandy ground where runnability is reduced to less than 80% of normal speed.

The symbol is orientated to north.

Minimum area: 1 mm x 1 mm (footprint 15 m x 15 m).

Colour: yellow 50%, black.



min. ▣

### 214 Bare rock (A)

A runnable area of rock without earth or vegetation should be shown as bare rock.

An area of rock covered with grass, moss or other low vegetation, shall not be shown using the bare rock symbol.

An area of less runnable bare rock should be shown using a stony ground symbol (210-212).

Minimum area: 1 mm x 1 mm (footprint 15 m x 15 m).

Colour: black 35%.

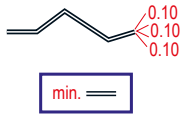

### 215 Trench (L)

Rocky or artificial trench. Minimum depth should be 1 m.

Minimum length: 1 mm (footprint 15 m).

Shorter trenches may be exaggerated to the minimum graphical dimension.

Impassable trenches shall be represented using symbol *Impassable cliff* (201).

Collapsed and easily crossable trenches should be mapped as erosion gullies.

Colour: black.

## 3.3 Water and marsh

This group includes both open water and special types of vegetation caused by the presence of water (marsh). The classification is important because it indicates runnability and provides features for map reading and control points. A black line around a water feature indicates that it is uncrossable. The features listed in this section may only contain water in some seasons. Marsh symbols are combined with area symbols for openness (yellow) and runnability (green and yellow).

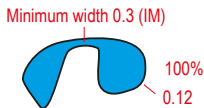

### 301 Uncrossable body of water (A)

An area of deep water such as a lake, pond or river which may constitute a danger to the competitor. The black bank line emphasises that the feature is uncrossable. Dominant areas of water may be shown with 70% colour. Small areas of water and bodies of water that have narrow parts shall always be shown with full colour.

Minimum width (inside): 0.3 mm.

Minimum area (inside): 0.55 mm x 0.55 mm (footprint 8 m x 8 m).

Colour: blue, black.

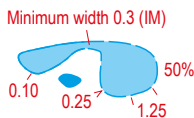

### 302 Shallow body of water (A)

An area of shallow water such as a pond or a river that can be crossed. The body of water should be less than 0.5 m deep and runnable. A shallow seasonal or periodic body of water may be represented using a dashed outline. Small shallow water bodies may be represented as 100% blue (without an outline).

Minimum width (inside): 0.3 mm.

Minimum area (inside): 0.7 mm x 0.7 mm (footprint 10.5 m x 10.5 m).

Minimum width (full colour): 0.3 mm.

Minimum area (full colour): 0.55 mm x 0.55 mm (footprint 8 m x 8 m).

Colour: blue (outline), blue 50%.

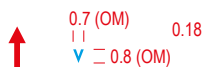

### 303 Waterhole (P)

A water-filled pit or an area of water which is too small to be shown to scale. Location is the centre of gravity of the symbol, and the symbol is orientated to north.

Footprint: 10.5 m x 12 m.

Colour: blue.



### 304 Crossable watercourse (L)

A crossable watercourse more than 2 m wide.  
Minimum length (isolated): 1 mm (footprint 15 m).  
Colour: blue.



### 305 Small crossable watercourse (L)

A crossable watercourse less than 2 m wide.  
Minimum length (isolated): 1 mm (footprint 15 m).  
Colour: blue.

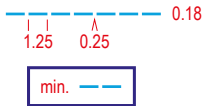

### 306 Minor/seasonal water channel (L)

A natural or man-made minor water channel which may contain water only intermittently.  
Minimum length (isolated): two dashes (2.75 mm - footprint 41 m).  
Colour: blue.

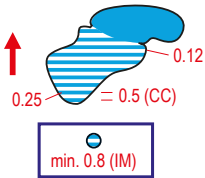

### 307 Uncrossable marsh (A)

A marsh which is uncrossable or dangerous for the competitor. The black outline emphasises that the feature is uncrossable. The black outline is omitted for boundaries between uncrossable marsh and symbol *Uncrossable body of water* (301). The symbol may be combined with a rough open land symbol (403, 404) to show openness. At least two blue lines shall be clearly visible.

The symbol is orientated to north.  
Minimum width: 2 lines or 0.8 mm (inside).  
Smaller areas must either be left out, exaggerated or shown using symbol *Uncrossable body of water* (301).  
Colour: black (outline), blue.

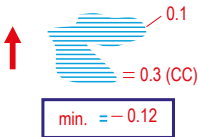

### 308 Marsh (A)

A crossable marsh, usually with a distinct edge.  
The symbol shall be combined with other symbols to show runnability and openness. At least two blue lines shall be clearly visible.  
The symbol is orientated to north.  
Minimum area: 0.5 mm x 0.4 mm (footprint 7.5 m x 6 m).  
Colour: blue.

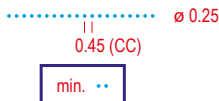

### 309 Narrow marsh (L)

A marsh or trickle of water which is too narrow (less than about 5 m wide) to be shown with symbol *Marsh* (308).  
Minimum length (isolated): two dots (0.7 mm - footprint 10.5 m).  
Colour: blue.

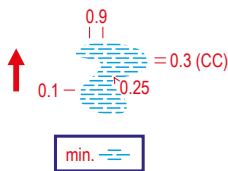

### 310 Indistinct marsh (A)

An indistinct marsh, seasonal marsh or an area of gradual transition from marsh to firm ground, which is crossable. The edge is generally indistinct and the vegetation similar to that of the surrounding ground.

The symbol shall be combined with other symbols to show runnability and openness.

The symbol is orientated to north.

Minimum area: 2.0 mm x 0.7 mm (footprint 30 m x 10.5 m).

Colour: blue.

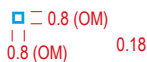

### 311 Well, fountain or water tank (P)

A prominent well, fountain, water tank or captive spring.

Footprint: 12 m x 12 m.

Colour: blue.

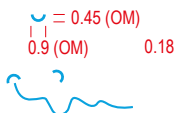

### 312 Spring (P)

A source of water.

Location is the centre of gravity of the symbol, and the symbol is orientated to open downstream.

Footprint: 13.5 m x 7 m.

Colour: blue.

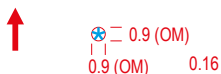

### 313 Prominent water feature (P)

The symbol is orientated to north.

The definition of the symbol must be given on the map.

Footprint: 13.5 m x 13.5 m.

Colour: blue.

## 3.4 Vegetation

The representation of vegetation is important to the competitor because it affects runnability and visibility and it also provides features for map reading.

### Colour and Runnability

The basic principle is as follows:

- **white** represents typical open forest,
- **yellow** represents open areas divided into several categories,
- **green** represents the density of the forest and undergrowth according to its runnability and is divided into several categories

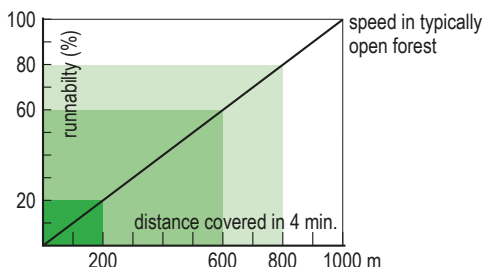

The runnability depends on the nature of the vegetation (density of trees / scrub and undergrowth: bracken, brambles, nettles, etc.), but runnability is also affected by marshes, stony ground, etc. which are shown by separate symbols.

Vegetation runnability is divided into categories according to running speed (see section 2.3).

#### 401 Open land (A)



100%



Open land that has a ground cover (grass, moss or similar) which offers better runnability than typical open forest. If yellow coloured areas become dominant, a screen (75% instead of full yellow) may be used.

Shall not be combined with area symbols other than *Broken ground* (113), *Boulder field* (208), *Marsh* (308) and *Indistinct marsh* (310).

Minimum area: 0.55 mm x 0.55 mm (footprint 8 m x 8 m).

Colour: yellow (or yellow 75%).

#### 402 Open land with scattered trees (A)

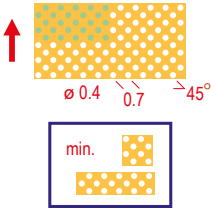

Areas with scattered trees or bushes in open land may be generalised by using a regular pattern of large dots in the yellow screen. The dots may be white (scattered trees) or green (scattered bushes / thickets). Prominent individual trees may be added using symbol *Prominent large tree* (417). If yellow coloured areas become dominant, a screen (75% instead of full yellow) may be used.

Shall not be combined with area symbols other than symbol *Broken ground* (113), symbol *Boulder field* (208) or marsh symbols (308, 310).

Minimum width: 1.5 mm (footprint 22.5 m).

Minimum area: 2 mm x 2 mm (footprint 30 m x 30 m).

Smaller areas must either be left out, exaggerated or shown using symbol *Open land* (401).

The symbol is orientated to north.

Colour: yellow (or yellow 75%) with holes of white or green 60%.

#### 403 Rough open land (A)



50%



Heath, moorland, felled areas, newly planted areas (trees lower than ca. 1 m) or other generally open land with rough ground vegetation, heather or tall grass offering the same runnability as typical open forest.

May be combined with symbol *Vegetation: slow running, good visibility* (407) or *Vegetation: walk, good visibility* (409) to show reduced runnability.

Minimum area: 1 mm x 1 mm (footprint 15 m x 15 m).

Smaller areas must either be left out, exaggerated or shown using symbol *Open land* (401).

Colour: yellow 50%.

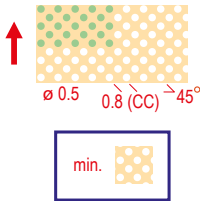

#### 404 Rough open land with scattered trees (A)

Areas with scattered trees or bushes in rough open land may be generalised by using a regular pattern of large dots in the yellow screen.

The dots may be white (scattered trees) or green (scattered bushes / thickets). Only the white dot variant can be combined with symbol *Vegetation: slow running, good visibility* (407) or *Vegetation: walk, good visibility* (409) to show reduced runnability.

The symbol is orientated to north.

Minimum width: 1.5 mm (footprint 22.5 m). Minimum area: 2.5 mm x 2.5 mm (footprint 37.5 m x 37.5 m).

Smaller areas must either be left out, exaggerated or shown using symbol *Rough open land* (403).

Colour: yellow 50% with holes of white, or green 60%.

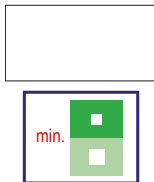

#### 405 Forest (A)

Typical open forest for the particular type of terrain. If no part of the forest is easily runnable then no white should appear on the map.

Minimum area: 1 mm x 1 mm (footprint 15 m x 15 m) for openings in screens of other colours, except for symbol *Vegetation: walk* (408) where the minimum area is 0.7 mm x 0.7 mm (footprint 10.5 m x 10.5 m). For openings in symbol *Open land* (401), the minimum area is 0.7 mm x 0.7 mm (footprint 10.5 m x 10.5 m). For openings in symbol *Vegetation: fight* (410) the minimum area is 0.55 mm x 0.55 mm (footprint 8 m x 8 m).

Colour: white.

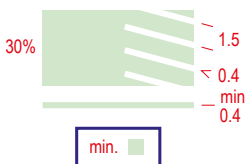

#### 406 Vegetation: slow running (A)

An area with dense vegetation (low visibility) which reduces running to about 60-80% of normal speed.

Where runnability is better in one direction, a regular pattern of white stripes is left in the screen to show the direction of better running.

Minimum area: 1 mm x 1 mm (footprint 15 m x 15 m).

Minimum width: 0.4 mm (footprint 6 m).

Colour: green 30%.

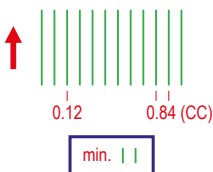

#### 407 Vegetation, slow running, good visibility (A)

An area of good visibility and reduced runnability, due to, for instance, undergrowth (brambles, heather, low bushes, cut branches). Running speed is reduced to about 60-80% of normal speed.

The symbol is orientated to north.

Minimum area: 1.5 mm x 1 mm (footprint 22.5 m x 15 m).

Colour: green.



#### 408 Vegetation: walk (A)

An area with dense trees or thickets (low visibility) which reduce running to about 20-60% of normal speed.

When runnability is better in one direction, a regular pattern of white / green 30% stripes is left in the screen to show the direction of better running.

Minimum area: 0.7 mm x 0.7 mm (footprint 10.5 m x 10.5 m).

Minimum width: 0.3 mm (footprint 4.5 m).

Colour: green 60% / green 30%.

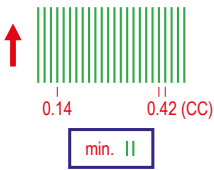

#### 409 Vegetation: walk, good visibility (A)

An area of good visibility that is difficult to run through, due to, for instance, undergrowth (brambles, heather, low bushes, cut branches). Running speed is reduced to about 20-60% of normal speed.

Areas of good visibility that are very difficult to run or impassable are represented using symbol *Vegetation: fight* (410).

The symbol is orientated to north.

Minimum area: 1 mm x 1 mm (footprint 15 m x 15 m).

Colour: green.



#### 410 Vegetation: fight (A)

An area of dense vegetation (trees or undergrowth) which is barely passable. Running reduced to less than about 20% of normal speed.

Where runnability is better in one direction, a regular pattern of white / green 30% / green 60% stripes is left in the screen to show the direction of better running.

Minimum area: 0.55 mm x 0.55 mm (footprint 8 m x 8 m).

Minimum width: 0.25 mm (footprint 3.8 m).

Colour: green / green 60% / green 30%.

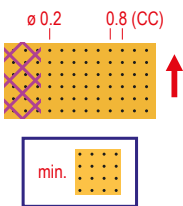

#### 412 Cultivated land (A)

Cultivated land, normally used for growing crops. Runnability may vary according to the type of crops grown and the time of year. For agroforestry, symbol *Forest* (405) or *Open land with scattered trees* (402) may be used instead of yellow.

Since the runnability may vary, such areas should be avoided when setting courses.

The symbol is combined with symbol *Out-of-bounds area* (709) to show cultivated land that shall not be entered.

The symbol is orientated to north.

Minimum area: 3 mm x 3 mm (footprint 45 m x 45 m).

Colour: yellow, black.



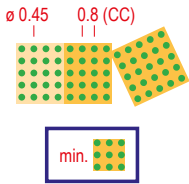

#### 413 Orchard (A)

Land planted with trees or bushes, normally in a regular pattern. The dot lines may be orientated to show the direction of planting.

Must be combined with either symbol *Open land* (401) or *Rough open land* (403).

May be combined with symbol *Vegetation: slow running, good visibility* (407) or *Vegetation: walk, good visibility* (409) to show reduced runnability.

Minimum area: 2 mm x 2 mm (footprint 30 m x 30 m).

Colour: green, yellow or yellow 50%.

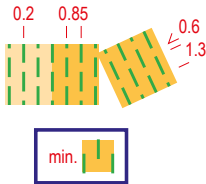

#### 414 Vineyard or similar (A)

A vineyard or similar cultivated land containing dense rows of plants offering good or normal runnability in the direction of planting. The lines shall be orientated to show the direction of planting. At least three lines shall be clearly visible. Must be combined with either symbol *Open land* (401) or *Rough open land* (403).

Minimum area: 2 mm x 2 mm (footprint 30 m x 30 m).

Colour: green, yellow or yellow 50%.



#### 415 Distinct cultivation boundary (L)

A boundary of cultivated land vegetation (symbols 401, 412, 413, 414) or a boundary between areas of cultivated land when not shown with other symbols (fence, wall, path, etc.).

Minimum length: 2 mm (footprint 30 m).

Colour: black.

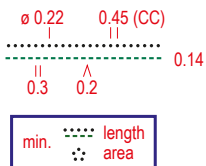

#### 416 Distinct vegetation boundary (L)

A vegetation boundary within the forest, or a distinct forest edge.

Only one of the vegetation boundary symbols (black dotted line or dashed green line) can be used on a map. For areas with a lot of rock features, it is recommended to use the green dashed line for vegetation boundaries.

The disadvantage with a green line is that it cannot be used to show distinct vegetation boundaries around and within symbol *Vegetation: fight* (410). An alternative for these situations is to use symbol *Distinct cultivation boundary* (415).

Minimum length, black dot implementation: 5 dots (2.0 mm - footprint 30 m).

Minimum length, green line implementation: 4 dashes (1.8 mm - footprint 27 m).

Colour: dark green (dashed line) / black (dotted line).



#### 417 Prominent large tree (P)

A very large single tree which clearly stands out from the surrounding vegetation.

White mask is used under the green circle, to improve readability in yellow and green (OM 1.1 mm).

Footprint: 13.5 m x 13.5 m

Colour: green, white.



#### 418 Prominent bush or tree (P)

A bush or small single tree which clearly stands out from the surrounding vegetation.

Use sparingly, as it is easily mistaken for symbol *Small knoll* (109). Small white dot inside is used to aid the colour vision impaired.

Footprint: 9.0 m x 9.0 m.

Colour: green, white.

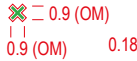

#### 419 Prominent vegetation feature (P)

A vegetation feature which is significant or prominent.

White mask is used under the green cross, to improve readability in yellow and green (line width of white mask 0.36 mm, and it shall be 0.18 mm longer in the ends of the symbol).

The symbol is orientated to north.

The definition of the symbol must be given on the map.

Footprint: 13.5 m x 13.5 m.

Colour: green, white.

### 3.5 Man-made features

The road and track network provides important information for the competitor and the classification must be clearly recognisable on the map. Of particular importance to the competitor is the classification of smaller paths. Account must be taken not only of the width but also of how obvious the path is to the competitor. Some man-made features constitute obstacles or barriers to the competitor and must be easily identifiable on the map. Important examples are fences, walls, buildings and forbidden areas. Other man-made features are important both for map reading and for control points.

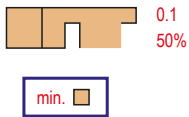

#### 501 Paved area (A)

An area with a firm surface such as asphalt, hard gravel, tiles, concrete or the like. Paved areas should be bordered (or framed) by a thin black line where they have a distinct boundary.

Minimum area: 1 mm x 1 mm (footprint 15 m x 15 m).

Colour: brown 50%, black.

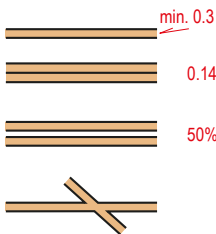

#### 502 Wide road (L)

A maintained road wider than 5 m wide suitable for vehicles in all weather.

The width should be drawn to scale, but not smaller than the minimum width (0.3 + 2\*0.14 mm - footprint 8.7 m). The outer boundary lines may be replaced with other black line symbols, such as symbol *Fence* (516), *Impassable fence* (518), *Wall* (513) or *Impassable wall* (515) if the feature is so close to the road edge that it cannot practically be shown as a separate symbol.

The space between the black lines is filled with brown (50%).

A road with two carriageways can be represented using two wide road symbols side by side, keeping only one of the road edges in the middle.

Colour: black, brown 50%.



0.35

### 503 Road (L)

A maintained road less than 5 m wide suitable for vehicles in all weather.  
Colour: black.

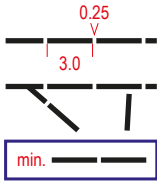

0.35

### 504 Vehicle track (L)

A track or poorly maintained road suitable for vehicles only when travelling slowly. For distinct junctions the dashes of the symbols are joined at the junction.

For indistinct junctions the dashes of the symbols are not joined.  
Minimum length (isolated): two dashes (6.25 mm - footprint 94 m).  
Colour: black.

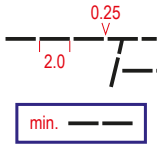

0.25

### 505 Footpath (L)

An easily runnable path, bicycle track or old vehicle track.

For distinct junctions the dashes of the symbols are joined at the junction.  
For indistinct junctions the dashes of the symbols are not joined.

Minimum length (isolated): two dashes (4.25 mm - footprint 64 m)  
Colour: black.

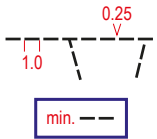

0.18

### 506 Small footpath (L)

A runnable small path or (temporary) forest extraction track which can be followed at competition speed.

For distinct junctions the dashes of the symbols are joined at the junction.  
For indistinct junctions the dashes of the symbols are not joined.

Minimum length (isolated): two dashes (2.25 mm - footprint 34 m).  
Colour: black.

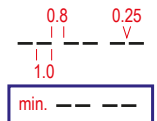

0.18

### 507 Less distinct small footpath (L)

A runnable less distinct / visible small path or forestry extraction track.

Minimum length: two sections of double dashes (5.3 mm - footprint 79.5 m).  
Colour: black.



0.14

0.45

### 508 Narrow ride or linear trace through the terrain (L)

A forest ride or a prominent trace (forestry extraction track, sandy track, ski track) through the terrain which does not have a distinct runnable path along it.

Runnability is shown using a slightly thicker line of yellow, green or white as background. Without outline: the same runnability as the surroundings.

Yellow 100%: easy running.

White in green: normal runnability.

Green 30%: slow running.

Green 60%: walk.

Minimum length: two dashes (3.25 mm - footprint 48 m).

Colour: black + white/green/yellow.

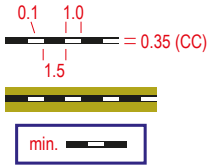

### 509 Railway (L)

A railway or other kind of railed track.

If it is forbidden to run along the railway, it shall be combined with symbol *Out-of-bounds route* (711). If it is forbidden to cross the railway, it must be combined with symbol *Area that shall not be entered* (520) or *Out-of-bounds area* (709).

Minimum length (isolated): two black dashes (4 mm - footprint 60 m).

Colour: black, white.

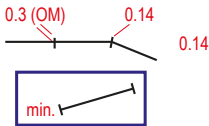

### 510 Power line, cableway or skilift (L, P)

Power line, cableway or skilift. The bars show the exact location of the pylons.

The line may be broken to improve legibility.

If a section of a power line, cableway or skilift goes along a road or path (and does not offer significant additional navigational value) it should be omitted.

Minimum length (isolated): 5 mm (footprint: 75 m).

Colour: black.

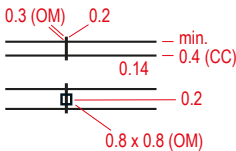

### 511 Major power line (L, P)

Major power lines should be drawn with a double line. The gap between the lines may indicate the extent of the power line. The lines may be broken to improve legibility. The bars show the exact location of the pylons. Very large carrying masts shall be represented in plan shape using outline of symbol *Building* (521) or with symbol *High tower* (524).

Colour: black.

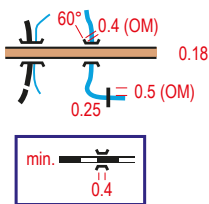

### 512 Bridge / tunnel (L, P)

Bridges and tunnels are represented using the same basic symbols.

If it is not possible to get through a tunnel (or under a bridge), it shall be omitted.

Minimum length (of baseline): 0.4 mm (footprint 6 m).

Small bridges connected to a track/path are shown by centring a track dash on the crossing. Tracks/paths are broken for water course crossings without bridges. A small footbridge with no path leading to it is represented with a single dash.

Colour: black.

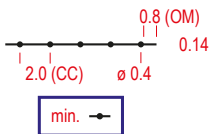

### 513.1 Wall (L)

A significant wall of stone, concrete, wood or other materials.

Minimum height: 1 m.

Minimum length (isolated): 1.4 mm (footprint 21 m).

Colour: black.

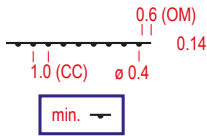

### 513.2 Retaining wall (L)

A significant wall of stone, concrete, wood or other materials which is seen only from one side. Half dot must point to the lower level. Minimum height: 0.5 m.

Minimum length (isolated): 1.4 mm (footprint 21 m).

Colour: black.

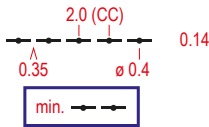

### 514 Ruined wall (L)

A ruined or less distinct wall. Minimum height 0.5 m.

Minimum length: two dashes (3.65 mm - footprint 55 m). If shorter, the symbol must be exaggerated to the minimum length or changed to symbol *Wall* (513.1).

Colour: black.

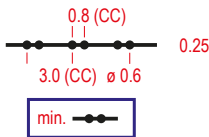

### 515 Impassable wall (L)

An impassable or uncrossable wall, normally more than 1.5 m high.

Minimum length (isolated): 3 mm (footprint 45 m).

Colour: black.

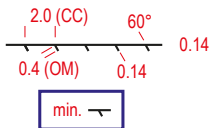

### 516 Fence (L)

A passable or crossable fence, normally less than 1.5 m high.

If the fence forms an enclosed area, tags should be placed inside.

Minimum length (isolated): 1.5 mm (footprint 22.5 m).

Colour: black.

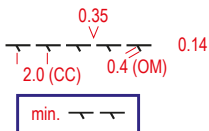

### 517 Ruined fence (L)

A ruined or less distinct fence. If the fence forms an enclosed area, tags should be placed inside.

Minimum length: two dashes (3.65 mm - footprint 55 m). If shorter, the symbol must be exaggerated to the minimum length or changed to symbol *Fence* (516).

Colour: black.

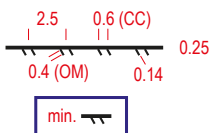

### 518 Impassable fence (L)

An impassable or uncrossable fence, normally more than 1.5 m high.

If the fence forms an enclosed area, tags should be placed inside.

Minimum length (isolated): 2 mm (footprint 30 m).

Colour: black.

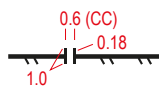

### 519 Crossing point (P)

A way through or over a wall, fence or other linear feature, including a gate or stile.

For uncrossable features, the line shall be broken at the crossing point. For passable features, the line shall not be broken if passing involves a degree of climb.

Colour: black.

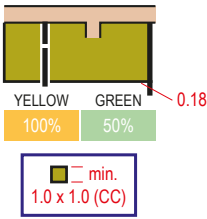

### 520 Area that shall not be entered (A)

An out-of-bounds area is a feature such as a private house, a garden, a factory or another industrial area. Only contours and prominent features such as railways and large buildings shall be shown inside an out-of-bounds area. The area shall be discontinued where a path goes through and white colour is used as background with overlap 0.15 mm on both sides.

Out-of-bound areas with a clear border shall be bounded by a black boundary line or another black line, if the border is unclear no black line shall occur. Course planning symbol 709 can be used for temporary out-of bounds areas. The vertical black stripes version of the symbol is orientated to north.

An out-of-bounds area shall not be entered.

Minimum area: 1 mm x 1 mm (footprint 15 m x 15 m).

Colour: yellow + green 50%, or black .

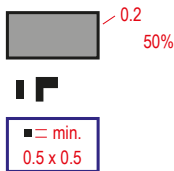

### 521 Building (A)

A building is shown with its ground plan so far as the scale permits.

Buildings larger than 75 m x 75 m may be represented with a dark grey infill in urban areas.

Passages through buildings must have a minimum width of 0.4 mm (footprint 6.0 m).

Buildings within forbidden areas are generalised.

Areas totally contained within a building shall not be mapped (they shall be represented as being part of the building). Minimum gap indicating a passage between buildings and between buildings and other impassable features should be 0.4 mm.

Minimum area: 0.5 mm x 0.5 mm (footprint 7.5 m x 7.5 m).

Colour: black (or black (outline), black 50%).

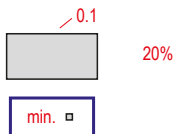

### 522 Canopy (A)

An accessible and runnable area with roof.

Minimum area (isolated): 0.6 mm x 0.6 mm (footprint 9 m x 9 m). Minimum (inside) width: 0.4 mm (footprint 6.0 m).

Colour: black 20%, black.

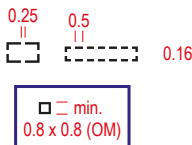

### 523 Ruin (L)

A ruined building. The ground plan of a ruin is shown to scale, down to the minimum size. Ruins that are so small that they cannot be drawn to scale may be represented using a solid line.

Minimum area (outside measures): 0.8 mm x 0.8 mm (footprint 12 m x 12 m).

Colour: black.

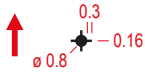

### 524 High tower (P)

A high tower or large pylon. If it is in a forest, it must be visible above the level of the surrounding forest. Towers with a larger footprint must be represented using symbol *Building* (521).

The symbol is orientated to north.

Footprint: 21 m in diameter.

Colour: black.

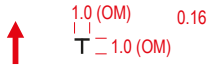

### 525 Small tower (P)

An obvious small tower or elevated platform or seat. The object shall be with elevation above the ground. Location is at the centre of gravity of the symbol.

The symbol is orientated to north.

Footprint: 15 m x 15 m.

Colour: black.

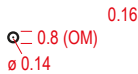

### 526 Cairn (P)

A prominent cairn, memorial stone, boundary stone or trigonometric point.

Minimum height: 0.5 m.

Footprint: 12 m in diameter.

Colour: black.

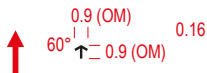

### 527 Fodder rack (P)

A fodder rack, which is free standing or attached to a tree.

Location is at the centre of gravity of the symbol.

The symbol is orientated to north.

Footprint: 13.5 m x 13.5 m.

Colour: black.

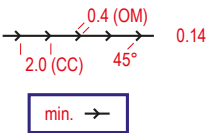

### 528 Prominent line feature (L)

A prominent man-made line feature. For example, a low pipeline (gas, water, oil, heat, etc.) or a bobsleigh / skeleton track that is clearly visible. The definition of the symbol must be given on the map.

Minimum length: 1.5 mm (footprint 22.5 m).

Colour: black.

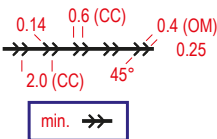

### 529 Prominent uncrossable line feature (L)

An uncrossable man-made line feature. For example, a high pipeline (gas, water, oil, heat, etc.) or a bobsleigh / skeleton track. The definition of the symbol must be given on the map.

Minimum length: 2 mm (footprint 30 m).

Colour: black.



### 530 Prominent man-made feature - ring (P)

Location is at the centre of gravity of the symbol.

The definition of the symbol must be given on the map.

Footprint: 12 m in diameter.

Colour: black.

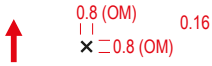

### 531 Prominent man-made feature - x (P)

Location is at the centre of gravity of the symbol.  
The symbol is orientated to north.  
The definition of the symbol must be given on the map.  
Footprint: 12 m x 12 m.  
Colour: black.

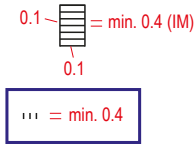

### 532 Stairway (L)

A distinct stairway through the terrain which helps to climb very steep slopes or to cross over impassable objects. A stairway going through rock passages or between impassable objects may be drawn without border lines.  
An easily runnable stairway or indistinct stairway should be drawn as a foot-path. Steps of a stairway shall be represented in a generalized manner.  
Minimum length: 3 (graphical) steps.  
Minimum width: 0.4 mm (IM).  
Colour: black.

## 3.6 Technical symbols

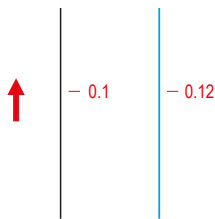

### 601 Magnetic north line (L)

Magnetic north lines are lines placed on the map pointing to magnetic north, parallel to the sides of the paper. Their spacing on the map shall be 20 mm on the map which represents 300 m on the ground at the scale of 1:15 000. If the map is enlarged to 1:10 000, the spacing of the lines will be 30 mm on the map.  
North lines shall be broken to improve the legibility of the map, for instance where they would obscure small features. In areas with very few water features, blue lines may be used.  
Colour: black or blue.



### 602 Registration mark (P)

At least three registration marks may be placed in the corners of the map. These can be used for printing courses on already printed maps. In addition, it allows a check of colour registration when printing colours separately.  
Colour: all printing colours.

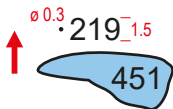

### 603 Spot height (P, T)

Spot heights are used for the rough assessment of height differences. The height is given to the nearest metre. Water levels are given without the dot. Spot heights must only be used where they do not conflict with other symbols.  
Font: sans-serif, 1.5 mm, non-bold, non-italic.  
Colour: black.



### 3.7 Course planning symbols

The dimensions of the course planning symbols are specified in mm at the printed scale of 1:15 000. For larger map scales the symbols shall be enlarged proportionally (to 150% for 1:10 000, to 300% for 1:5 000). All course planning symbols shall be printed over the map content. They shall not mask out map detail of at least black, brown and blue 100%. **Drawings in this sections are at 1:15 000.**

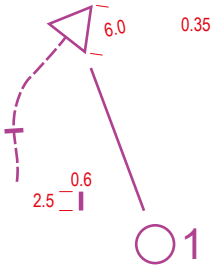

#### 701 Start (P)

The place where the orienteering starts. The centre of the triangle shows the precise position where the orienteering course starts. The start must be on a clearly identifiable point on the map. The triangle points in the direction of the first control.

Colour: purple (lower purple).

#### 702 Map issue point (P)

If there is a marked route to the start point, the map issue point is marked using this symbol.

Colour: purple (upper purple).



#### 703 Control point (P)

For point features, the centre of the circle shall be the centre of the symbol. For line and area features, the centre of the circle shows the precise position of the control marker. Controls shall only be placed on points that are clearly identifiable on the map.

Sections of the circle should be omitted to leave important detail showing.

Footprint 75 mm

Colour: purple (lower purple).

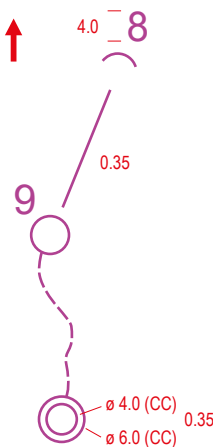

#### 704 Control number (T)

The number of the control is placed close to the control point circle in such a way that it does not obscure important detail. The numbers are orientated to north.

Font: Arial, 4.0 mm, non-bold, non-italic.

Colour: purple (lower purple).

#### 705 Course line (L)

Where controls are to be visited in order, the sequence is shown using straight lines from the start to the first control and then from each control to the next one. Sections of lines should be omitted to leave important detail showing. The line should be drawn via mandatory crossing points. There should be gaps between the line and the control circle in order to increase the readability of the underlying detail close to the control.

Colour: purple (lower purple).

#### 706 Finish (P)

The end of the course.

Colour: purple (lower purple).

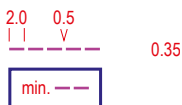

### 707 Marked route (L)

A marked route that is a part of the course. It is mandatory to follow the marked route.

Minimum length: 2 dashes (4.5 mm – footprint: 67.5 m).

Colour: purple (upper purple).

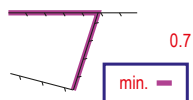

### 708 Out-of-bounds boundary (L)

A boundary which it is not permitted to cross.

An out-of-bounds boundary shall not be crossed.

Minimum length: 1 mm (footprint: 15 m).

Colour: purple (lower purple).

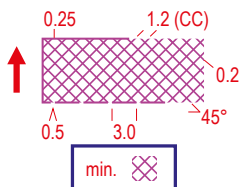

### 709 Out-of-bounds area (A)

An out-of-bounds area. A bounding line may be drawn if there is no natural boundary, as follows:

- A solid line indicates that the boundary is marked continuously (tapes, etc.) in the terrain.
- A dashed line indicates intermittent marking in the terrain.
- No line indicates no marking in the terrain.

An out-of-bounds area shall not be entered.

Minimum width: 3 mm.

Minimum area: 3 mm x 3 mm (footprint 45 m x 45 m).

Colour: purple (upper purple).

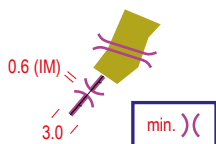

### 710 Crossing point (L)

A crossing point, for instance through or over a wall or fence, across a road or railway, through a tunnel or out-of-bounds area, or over an uncrossable boundary is drawn on the map with two lines curving outwards. The lines shall reflect the length of the crossing.

Colour: purple (lower purple).

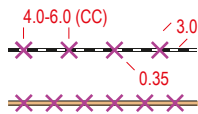

### 711 Out-of-bounds route (L)

A route which is out-of-bounds. Competitors are allowed to cross directly over a forbidden route, but it is forbidden to go along it.

An out-of-bounds route shall not be used.

Minimum length: 2 symbols (6 mm - footprint 90 m).

Colour: purple (upper purple).



### 712 First aid post (P)

The location of a first aid post.

Colour: purple (lower purple).

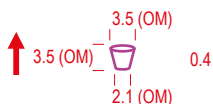

### 713 Refreshment point (P)

The location of a refreshment point which is not at a control.

Colour: purple (lower purple).



### 715 Continuing point after map exchange (P)

Symbol marking the continuation of the course after the map flip or the map exchange. The triangle points in the direction of the following control. Colour: purple (lower purple).

## 3.8 Precise definition of symbols

**Note: dimensions are specified in mm.**

All drawings are magnified (10x) for clarity only. The centre of gravity is marked (x) when it is not unambiguous.

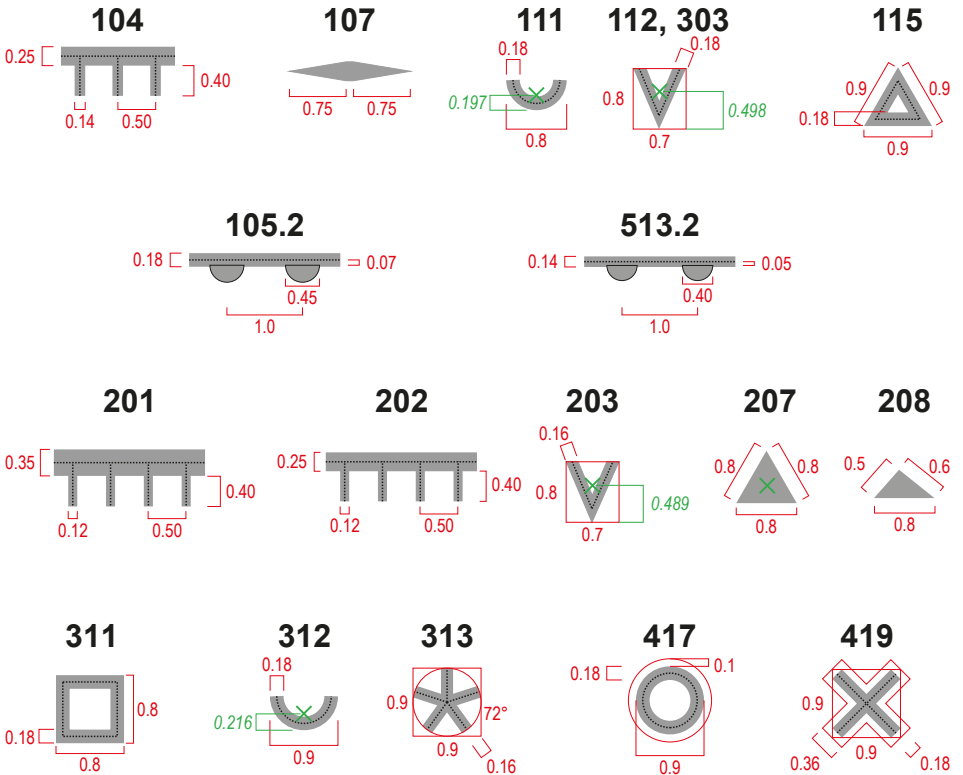

**524**

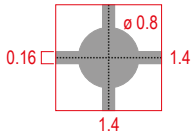

**525**

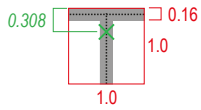

**526**



**527**

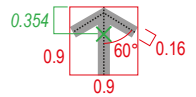

**516**

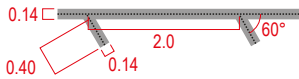

**518**

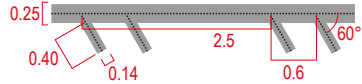

**528**

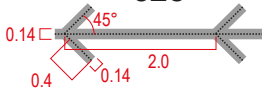

**529**

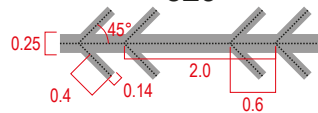

**530**



**531**

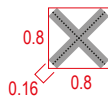

**713**

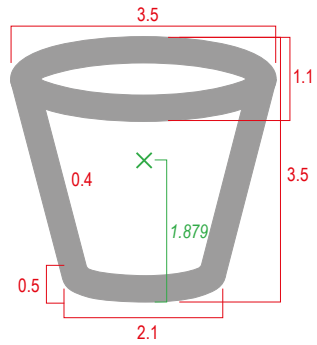

**Errata** (changes to the document):

<b>Date</b>	<b>Nr</b>	<b>Symbol</b>	<b>Description</b>
20.01.2020	415	Distinct cultivation boundary	Change of line width: 0.14 --> 0.10 mm.
20.01.2020	214	Bare rock	Change of colour: grey or black 25% --> black 30%.
20.01.2020	521	Building	Change of colour: black 65% --> black 60%.
20.01.2020	701 -713	Course planning symbols	Precise definition of colour: upper and lower purple.
23.01.2022	108	Small erosion gully	Minimum number of dots: 3 --> 2.
23.01.2022	416	Distinct vegetation boundary	Change of colour: green 100% and black 50% --> dark green (100 0 80 30).
23.01.2022	513.1	Wall	Change of symbol number: 513 --> 513.1.
23.01.2022	513.2	Retained wall	New symbol.
23.01.2022	521	Building	Change of colour of large buildings: 60% --> 50%.
23.01.2022	601	Magnetic north line	Change of line width of blue line: 0.18 --> 0.12 mm.
23.01.2022	709	Out of bounds area	Change of line width of cross hatch: 0.25 --> 0.2 mm; Change of gap of cross hatch: 0.8 --> 1.2 mm; Change of minimum sizes.
15.02.2022	307	Uncrossable marsh	Change of minimum size.
15.02.2022	408	Vegetation: walk	Correction of the graphic of the symbol.
15.02.2022	416	Distinct vegetation boundary	Correction of minimum size.
15.02.2022	514	Ruined wall	Correction of the graphic of the symbol.
15.02.2022	517	Ruined fence	Correction of the graphic of the symbol.
15.02.2022	520	Area that shall not be entered	Correction of minimum size.
15.02.2022	711	Out-of-bounds route	Correction of the graphic of the symbol.
07.04.2022	704	Control number	Change of colour: upper --> lower purple.
16.09.2022			Correction of the name of the Colour appendix.
16.09.2022	104	Earth bank	Correction of the graphic of the symbol.
16.09.2022	201	Impassable Cliff	Correction of the graphic of the symbol
16.09.2022	202	Cliff	Change of minimum distance: 0.2 --> 0.15; Correction of the graphic of the symbol.
16.09.2022	206	Gigantic boulder or rock pillar	Correction of Minimum size: 0.3 --> 0.25.
16.09.2022	408	Vegetation: walk	Addition of colour green 30%.
16.09.2022	410	Vegetation: fight	Addition of colour green 60 % / green 30%; Correction of green 20% --> green 30%; Correction of the graphic of the symbol.

Date	Nr	Symbol	Description
16.09.2022	416	Distinct vegetation boundary	Correction of definition of the symbol.
20.01.2024		1.1 Conventions	Adding text: Impassable / Uncrossable features.
20.01.2024		2.11.4 Screens	New table of permissible combinations of screens
20.01.2024	101	Contour	Change of text: Contours <b>shall</b> be adapted <b>or broken</b>
20.01.2024	104	Earth bank	Change of line width: 0.18 --> 0.25 mm.
20.01.2024	105.1	Earth wall	Renumbering of symbol.
20.01.2024	105.2	Retained earth wall	New symbol.
20.01.2024	107	Erosion gully	Change of footprint: 17 --> 17.25 m; Change of text: Contour lines <b>may</b> be broken around this symbol <b>for better readability</b> .
20.01.2024	108	Small erosion gully	Change of text: A small erosion gully or dry ditch. Contour lines <b>shall</b> be broken around this symbol.
20.01.2024	203.1	Rocky pit or cave	Renumbering of symbol.
20.01.2024	203.2	Dangerous pit	New symbol.
20.01.2024	214	Bare rock	Change of colour: black 30% --> black 35%
20.01.2024	301	Uncrossable body of water	More detailed symbol definition; Deletion of minimum graphic.
20.01.2024	302	Shallow body of water	More detailed symbol definition; Deletion of minimum graphic.
20.01.2024	304	Crossable watercourse	More detailed symbol definition.
20.01.2024	305	Small crossable watercourse	More detailed symbol definition.
20.01.2024	307	Uncrossable marsh	Change of line width: 0.18 --> 0.12 mm.
20.01.2024	308	Marsh	Change line width of minimum graphic: 0.1 --> 0.12 mm.
20.01.2024	417	Prominent large tree	More detailed symbol definition.
20.01.2024	418	Prominent bush or tree	More detailed symbol definition.
20.01.2024	419	Prominent vegetation feature	More detailed symbol definition.
20.01.2024	502	Wide road	More detailed symbol definition.
20.01.2024	503	Road	More detailed symbol definition.
20.01.2024	509	Railway	Change in text: Minimum length (isolated): two <b>black</b> dashes (4 mm - footprint 60 m).
20.01.2024	513.2	Retained wall	Change of minimum height: 1.0 --> 0.5 m; Change of minimum length: 2.4 --> 1.4 mm. Shift of the half dots by 0.05 mm from the center line.
20.01.2024	516	Fence	More detailed symbol definition.



